

# US94 Pushbutton

A classic square button with an opal pressel covered by a clear cap, allowing the whole faceplate to illuminate with a wide variety of colour options.

The pushbutton is made up of four elements: switch body, illumination, pressel, and surround. This data sheet includes detailed information on each element and the options available for the US94 pushbutton.

Image shows US94 pushbutton with Compact 3 switch body and black plastic surround. Pressel is opal polycarbonate with a clear plastic cap, illuminated in blue.

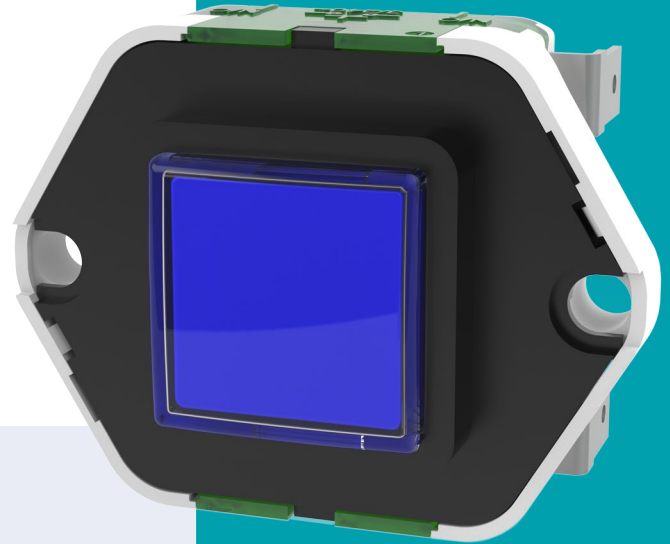

## Switch body

The switch body is the functional part of the pushbutton. The US94 is available with Compact 3, Compact 3P and Compact 2 Micro switch bodies.

## Pressel

The pressel is the faceplate of the pushbutton. US94 pressels are made out of opal polycarbonate, with a clear plastic cap which sits on top.

The US94 is available with or without a legend. There is an extensive range of legends to choose from, and any legend can be engraved onto the pressel.

## Illumination

Single, dual, bicolour and bicolour+ LED illumination options are available for the US94. All options illuminate the full pressel. They are easily replaceable and available in blue, white, red, amber and green.

## Surround

The surround is the element of the pushbutton which sits in front of the pressel and clicks into the switch body.

US94 pushbutton surrounds are made out of black plastic and create a black border around the pressel.

## Key features

- Complete pressel illumination available in a wide variety of colours.
- Pressel is made out of opal polycarbonate.
- Plastic surround creates a black border around the pressel.
- Extensive range of pressel legends to choose from with bespoke designs available on request.
- Legends are 15mm high, engraved into the pressel.

# Switch body | Compact 3 & Compact 3P

The switch body is the functional part of the pushbutton. Both the Compact 3 and 3P switch bodies offer the full range of illumination options as well as all possible contact configurations.

## Dimensions

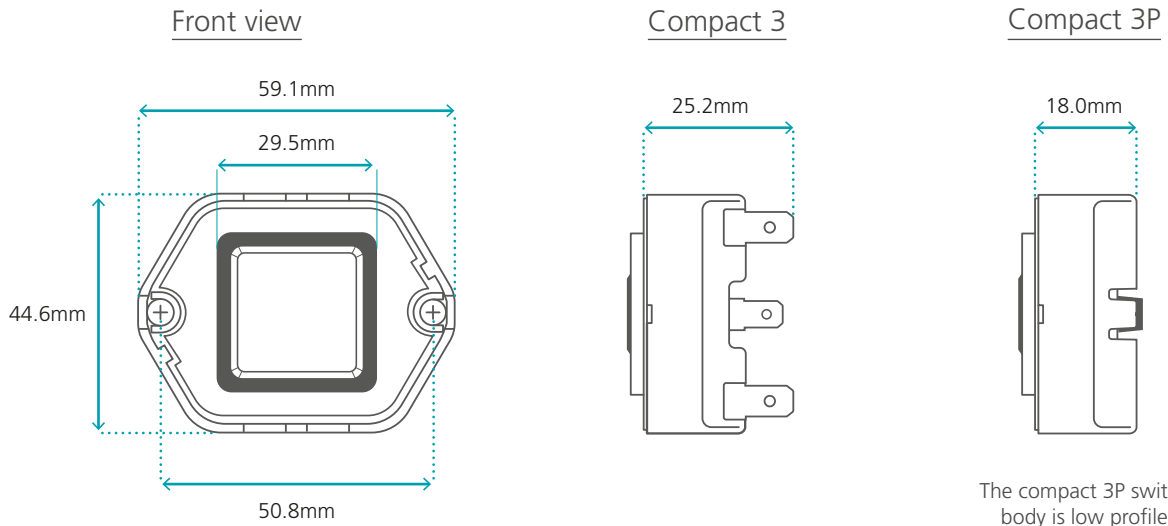

## Technical details

<b>Power (continuous)</b>	2.5 watts (maximum)
<b>Contact arrangements</b>	2 Normally Open contacts
	2 Normally Closed contacts
	1 Normally Open contact and 1 Normally Closed contact

Dewhurst **Compact 3** & **Compact 3P** switch bodies are designed and tested to last



**over 10 million operations.**

## Cutouts & stud positions

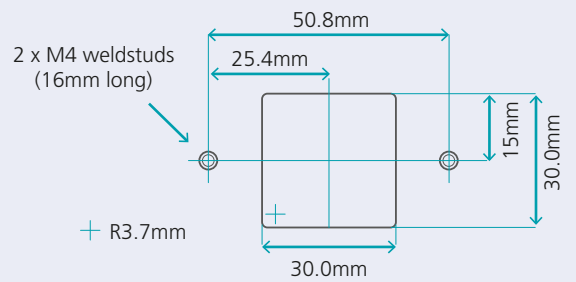

Pushbuttons with Compact 3 and Compact 3P switch bodies can be supplied loose or incorporated into stations. These have a vertical pitch of 50mm and a horizontal pitch of 60mm (Compact 3), or 80mm (Compact 3P), which means the switch body can be rotated 90 degrees.

If the pushbutton is supplied loose, spacers will be provided to accommodate the differing faceplate thickness.

# Switch body | Compact 2 Micro

The switch body is the functional part of the pushbutton. The Compact 2 Micro switch body is available with one NO contact configuration. It also offers single, dual and bicolour illumination options.

## Dimensions

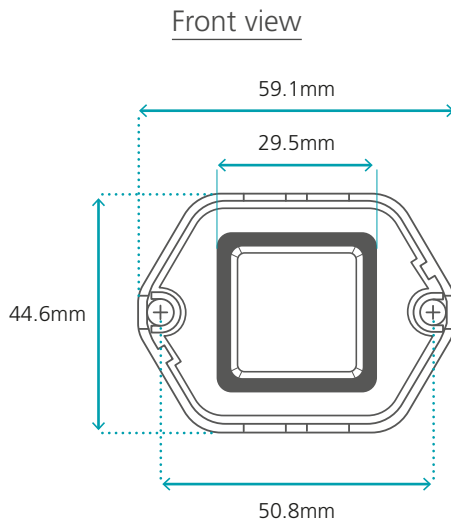

## Compact 2 Micro

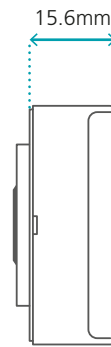

The compact 2 Micro switch body is low profile.

## Technical details

<b>Power (continuous)</b>	2.5 watts (maximum)
<b>Contact arrangement</b>	1 Normally Open contact

Dewhurst **Compact 2 Micro** switch bodies are designed and tested to last



over **1 million operations.**

## Cutouts & stud positions

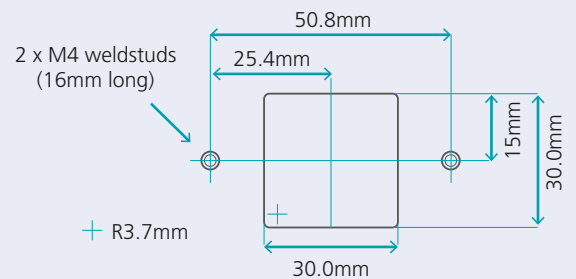

Pushbuttons with Compact 2 Micro switch body can be supplied loose or incorporated into stations. These have a vertical pitch of 50mm and a horizontal pitch of 60mm, which means the switch body can be rotated 90 degrees.

If the pushbutton is supplied loose, spacers will be provided to accommodate the differing faceplate thickness.



# Illumination

There are a wide range of interchangeable and easily replaceable LED illumination options available for Dewhurst pushbuttons. All options illuminate the full pressel.



The US94 offers a choice of single, dual, bicolour and bicolour+ illumination, all of which are available with Compact 3 and Compact 3P switch bodies. The Compact 2 Micro switch body comes with single, dual or bicolour illumination.

LED colours are available in blue, white, red, amber and green.



## Single illumination

Before call acceptance	After call acceptance
	
Both the legend and the halo are non-illuminated	The legend and halo are both illuminated at full brightness of any colour

## Dual illumination



Before call acceptance	After call acceptance
	
Both the legend and the halo are illuminated at 10% of full brightness of any colour	The legend and halo are both illuminated at full brightness of the same colour

## Bicolour illumination

Before call acceptance	After call acceptance
	
Both the legend and the halo are illuminated white at 10% of full brightness	The legend and halo are both illuminated at full brightness of any colour

Note: the initial white illumination before call acceptance is still visible after call acceptance. This may result in the chosen colour being slightly lighter than full brightness of other illumination options.

## Bicolour+ illumination

Before call acceptance	After call acceptance
	
Both the legend and the halo are illuminated at full brightness of any initial colour	The legend and halo are both illuminated at full brightness of a different colour

Note: Bicolour+ illumination isn't available with the Compact 2 Micro switch body.

## Technical details

LED current	20mA (typically)
LED voltage ( $\pm 15\%$ )	12V DC, 24V DC, 110V AC

# Pressel

The US94 pressel (the faceplate of the pushbutton) is made out of opal polycarbonate and covered with a clear plastic cap. US94 pushbuttons are available with or without a legend. All legends are 15mm high and engraved onto the pressel. There is an extensive range of pressel legends to choose from.

## Material finishes

.....

Opal polycarbonate  
without legend

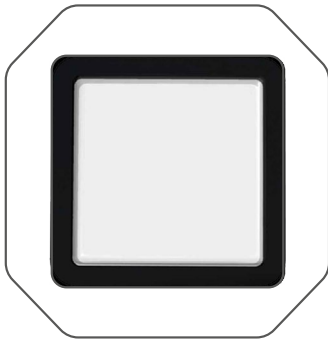

Opal polycarbonate  
with engraved legend



# Surround

The surround is the element of the pushbutton which sits in front of the pressel and clicks into the switch body. US94 pushbutton surrounds are made out of black plastic.

## Material finish

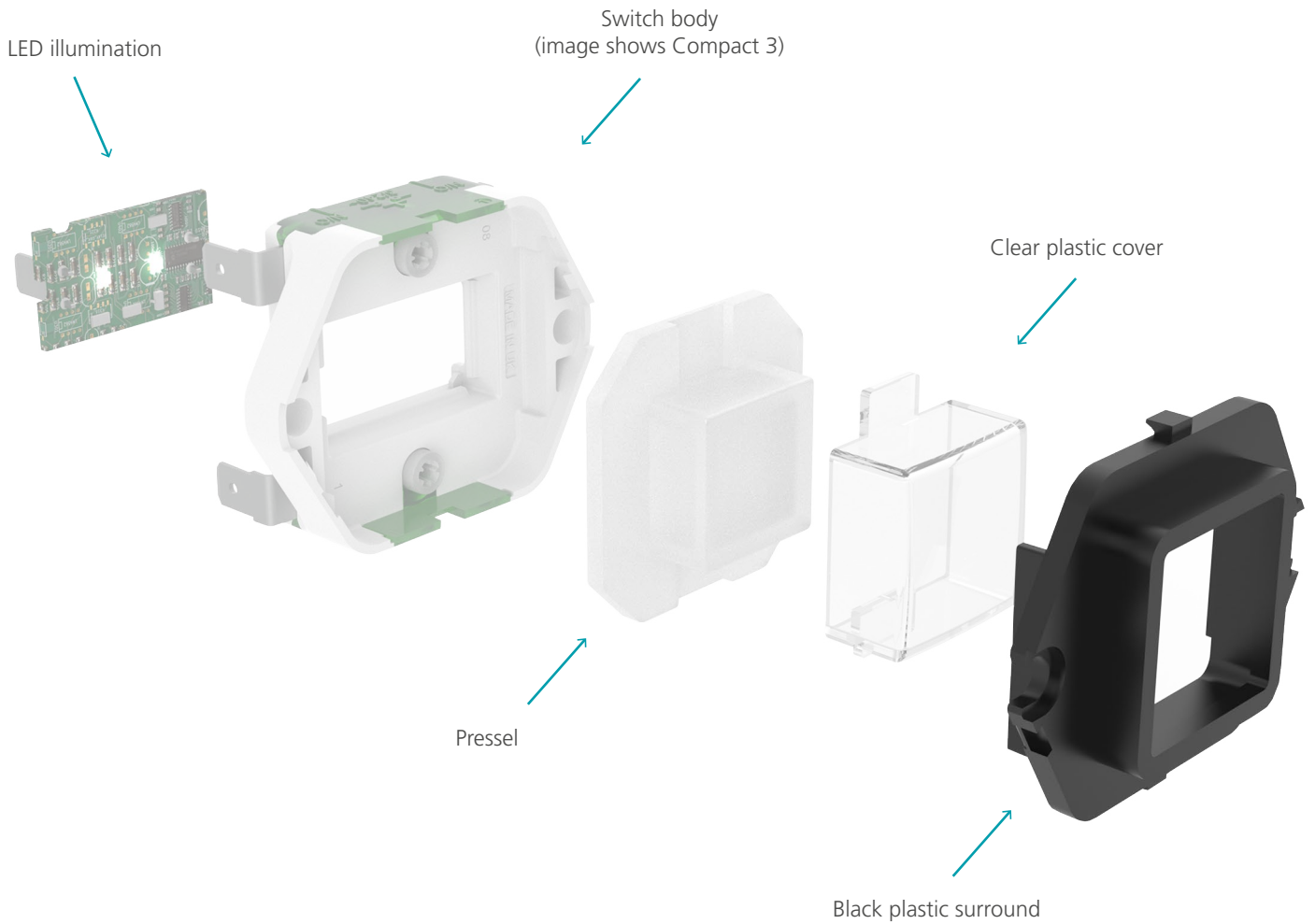

## Surround depths

All measurements are the protrusion through the faceplate.

Standard	B44	Exit	Long neck
(a) 3mm	(b) 4.6mm	(c) 7.1mm	(d) 12mm, 14mm OR 22mm

# Cleaning your Dewhurst pushbutton

Many Dewhurst lift products are made of polycarbonate (Using GE's Lexan® or Bayer's Makrolon®). The US94 is highly durable and vandal resistant, but plastic parts can be damaged by aggressive cleaning agents.

## Recommended guidance



Clean with a **cotton cloth** and **warm water** before applying the cleaning product.



Use **PH-neutral** or slightly acid cleaning products only (including aromatised ones).



**Ethylic alcohol, isopropyl alcohol or ethylene glycol** based multipurpose cleaning products and dish soaps are suggested. Dilute the cleaning product in warm water and apply using a wet cotton cloth.



Grease, glue and paint may be removed with **ethylic alcohol or isopropyl alcohol**.

## DO NOT USE

- ✗ Abrasive cleaning agents
- ✗ Cleaning agents at high temperatures
- ✗ Antibacterial detergent
- ✗ Sharp tools to remove dirt (chewing gum, glue, etc.)
- ✗ Solvents based with Ketones, benzene, methanol, toluene (methylbenzene or phenyl methane)
- ✗ Alkaline and ammonia based cleaning agents or ones containing citrus

**DO NOT** leave cleaning agents on the parts for long periods of time: remove immediately after cleaning using a damp cotton cloth.