

# US90-30 Jumbo Pushbutton

The square shaped US90-30 braille pushbutton is extra-large, primarily designed for use in larger buildings such as hospitals, airports and shopping centres. The pushbutton is made up of four elements: switch body, illumination, pressel, and surround. This data sheet includes detailed information on each element and the options available.

The character or symbol, known as the legend, provides clear identification. The legend and the halo (light created between the pressel and the surround) can be illuminated in a wide variety of colours.

Image shows US90-30 Jumbo pushbutton with Jumbo switch body, chrome surround, and brushed stainless steel pressel. Legend illuminated in red.



## Switch body

The switch body is the functional part of the pushbutton. The US90-30 Jumbo is available with the Jumbo and Jumbo P switch bodies.

## Pressel

The pressel is the faceplate of the pushbutton, and is available in a range of material finishes, including brushed stainless steel, mirror stainless steel, brushed brass and mirror brass. Standard US90-30 Jumbo pressels are moulded with opal polycarbonate.

There is an extensive range of pressel legends to choose from. All legends are 30mm high embossed and tactile, with standard English braille dots.

## Illumination

Single, dual, bicolour and bicolour+ LED illumination options are available for the US90-30. These illuminate both the legend and the halo. They are easily replaceable and available in blue, white, red, amber and green.

## Surround

The surround is the element of the pushbutton which sits in front of the pressel and clicks into the switch body. US90-30 pushbutton surrounds are available in a wide variety of material, depth and colour.

Standard material finishes include clear plastic, chrome, brass, satin chrome, black and green.

## Key features

- Extra-large pressel ideal for larger buildings.
- Extensive range of pressel legends to choose from with bespoke designs available on request.
- Identical appearance to the standard sized US90-15, so both sizes can be used together.
- Legends are 30mm high embossed and tactile with braille.
- Legend and halo illumination.
- Vandal resistant - meets EN81-71.
- Standard pressels are a stainless steel plate moulded with opal polycarbonate.

# Switch body | Jumbo & Jumbo P

The switch body is the functional part of the pushbutton. Both the Jumbo and Jumbo P switch bodies offer the full range of illumination options as well as all possible contact configurations. They also both accept shunt boards.

## Dimensions

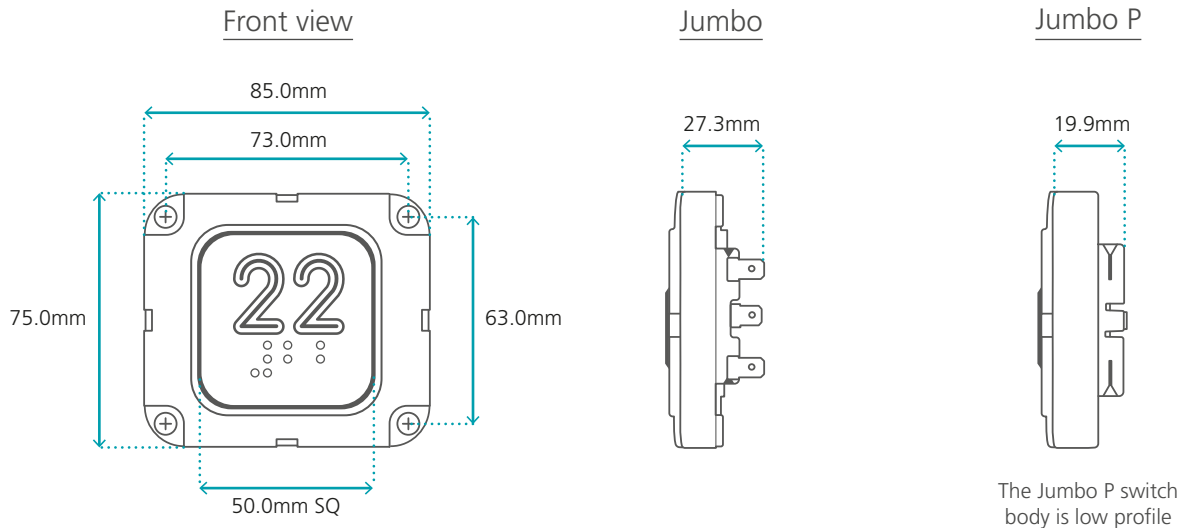

## Technical details

<b>Power (continuous)</b>	2.5 watts (maximum)
<b>Contact arrangements</b>	2 Normally Open contacts
	2 Normally Closed contacts
	1 Normally Open contact and 1 Normally Closed contact
<b>Wago cable size</b>	Up to 0.75mm <sup>2</sup> solid or flexible (only apply slight pressure when inserting/removing cable)

<b>Environmental protection (IP rating)</b>	EN60529 (IP54)
<b>Vandal resistance</b>	EN81-71
<b>Code compliance</b>	EN81-20, EN81-70

## Cutouts & stud positions

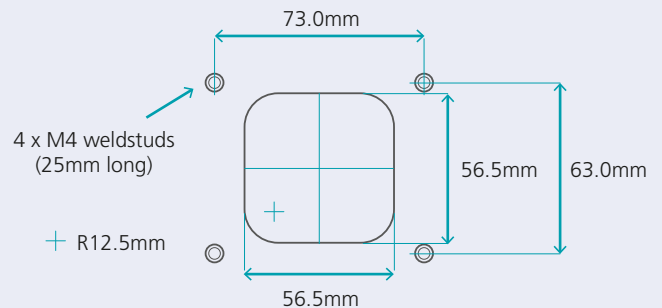

Pushbuttons with Jumbo and Jumbo P switch bodies can be supplied loose or incorporated into stations. These have a vertical pitch of 80mm and horizontal pitch of 90mm, which means the pushbutton body can be rotated 90 degrees.

If the pushbutton is supplied loose, spacers will be provided to accommodate the differing faceplate thickness.

Dewhurst **Jumbo & Jumbo P** switch bodies are designed and tested to last

over **10 million operations.**

# Illumination

There are a wide range of interchangeable and easily replaceable LED illumination options available for Dewhurst pushbuttons. All options illuminate both the legend (character or symbol) and the halo (circle of light created between the pressel and the surround).

The US90-30 offers a choice of single, dual, bicolour and bicolour+ illumination, all of which are available with Jumbo and Jumbo P switch bodies. LED colours are available in blue, white, red, amber and green.

## Single illumination

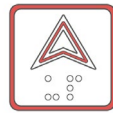
Before call acceptance	After call acceptance
	
Both the legend and the halo are non-illuminated	The legend and halo are both illuminated at full brightness of any colour

## Dual illumination

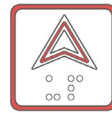
Before call acceptance	After call acceptance
	
Both the legend and the halo are illuminated at 10% of full brightness of any colour	The legend and halo are both illuminated at full brightness of the same colour

## Bicolour illumination

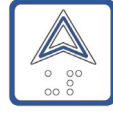
Before call acceptance	After call acceptance
	
Both the legend and the halo are illuminated white at 10% of full brightness	The legend and halo are both illuminated at full brightness of any colour

## Bicolour+ illumination

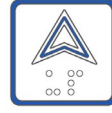
Before call acceptance	After call acceptance
	
Both the legend and the halo are illuminated at full brightness of any initial colour	The legend and halo are both illuminated at full brightness of a different colour

Note: the initial white illumination before call acceptance is still visible after call acceptance. This may result in the chosen colour being slightly lighter than full brightness of other illumination options.

## Technical details

LED current	20mA (typically)
LED voltage ( $\pm 15\%$ )	12V DC, 24V DC, 110V AC

# Pressel

The pressel (the faceplate of the Dewhurst pushbutton) is available in a range of standard material finishes. There is an extensive range of pressel legends to choose from. All legends are 30mm high and tactile, with standard English braille dots below. Bespoke characters are available on request.

## Material finishes

Brushed stainless steel



Mirror stainless steel



Brushed brass



Mirror brass



Standard US90-30 Jumbo pressels are moulded with opal polycarbonate, but other colours are available on request.

# Surround

The surround is the element of the pushbutton which sits in front of the pressel and clicks into the switch body. Dewhurst pushbutton surrounds are available in a wide variety of material, depth and colour.

## Material finishes

Standard material finishes include clear plastic, chrome, brass, satin chrome, black and green.

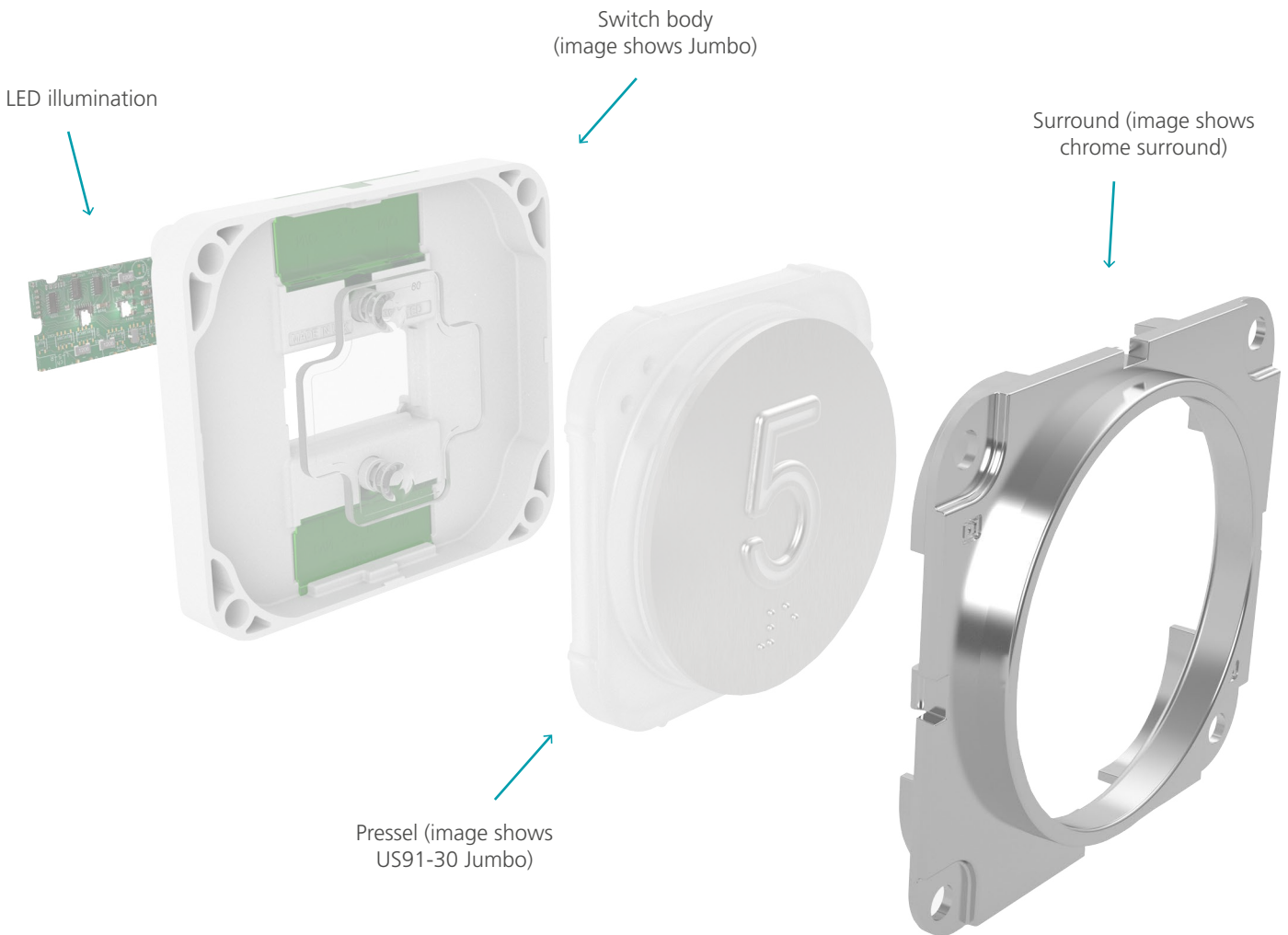

## Surround depths

All measurements are the protrusion through the faceplate.

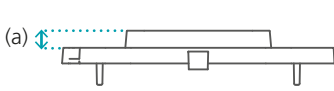
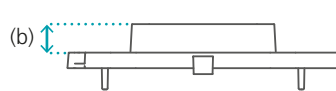
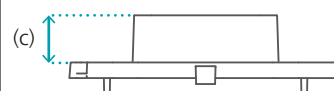
Standard	B44	Exit
		
(a) 3mm	(b) 4.6mm	(c) 7.1mm

# Cleaning your Dewhurst pushbutton

Many Dewhurst lift products are made of polycarbonate (Using GE's Lexan® or Bayer's Makrolon®). The US90-30 is highly durable and vandal resistant, but plastic parts can be damaged by aggressive cleaning agents.

## Recommended guidance



Clean with a **cotton cloth** and **warm water** before applying the cleaning product.



Use **PH-neutral** or slightly acid cleaning products only (including aromatised ones).



**Ethylic alcohol, isopropyl alcohol** or **ethylene glycol** based multipurpose cleaning products and dish soaps are suggested. Dilute the cleaning product in warm water and apply using a wet cotton cloth.



Grease, glue and paint may be removed with **ethylic alcohol** or **isopropyl alcohol**.

## DO NOT USE

- ✗ Abrasive cleaning agents
- ✗ Cleaning agents at high temperatures
- ✗ Antibacterial detergent
- ✗ Sharp tools to remove dirt (chewing gum, glue, etc.)
- ✗ Solvents based with Ketones, benzene, methanol, toluene (methylbenzene or phenyl methane)
- ✗ Alkaline and ammonia based cleaning agents or ones containing citrus

**DO NOT** leave cleaning agents on the parts for long periods of time: remove immediately after cleaning using a damp cotton cloth.